

Rotinas em Autolisp com apoio do Microsoft Excel



Sumário

| | | | |
|---|----|---|----|
| SAM_02 : Área Construída em metros..... | 01 | SAM_24 : Array Polar Simplificado..... | 19 |
| SAM_07 : Layers Principais..... | 02 | SAM_25 : Array Retangular Simplificado..... | 20 |
| SAM_08 : Folhas A4 e A3..... | 03 | SAM_26 : Chavetas DIN 6885..... | 21 |
| SAM_09 : Arruelas DIN 125 A..... | 04 | SAM_27 : Furos Roscados - Vista Superior..... | 22 |
| SAM_10 : Círculos Concêntricos..... | 05 | SAM_28 : Rolamento Fixo de Esferas..... | 23 |
| SAM_11 : Parafusos Tipo Allen..... | 06 | SAM_29 : Cálculo do Perímetro..... | 24 |
| SAM_12 : Rebaixos Allen DIN 74..... | 07 | SAM_30 : Circunferências - Matriz Quadrada..... | 25 |
| SAM_13 : Sinal de Corte Mecânica..... | 08 | SAM_31 : Matriz Quadrada de Linhas..... | 26 |
| SAM_14 : Porcas DIN 934..... | 09 | SAM_32 : Abertura da Janela Horizontal..... | 27 |
| SAM_15 : Furos Roscados Lateral..... | 10 | SAM_33 : Abertura da Janela Vertical..... | 28 |
| SAM_16 : Esboço de Eixos..... | 11 | SAM_34 : Região Construída Aberta..... | 29 |
| SAM_17 : Sketch Cad para SolidWorks..... | 12 | SAM_35 : Região Construída Fechada..... | 30 |
| SAM_18 : Furos em placas - Roscados ou não..... | 13 | SAM_36 : Janela Simplificada Horizontal..... | 31 |
| SAM_19 : Linhas de Centro - Linhas Paralelas..... | 14 | SAM_37 : Janela Simplificada Vertical..... | 32 |
| SAM_20 : Linhas de Centro em Furos..... | 15 | SAM_38 : Porta Simplificada..... | 33 |
| SAM_21 : Lâmpadas - Elétrica Residencial..... | 16 | SAM_39 : Vão da Porta Horizontal..... | 34 |
| SAM_22 : Numeração - Folha de Detalhes..... | 17 | SAM_40 : Vão da Porta Vertical..... | 35 |
| SAM_23 : Numeração - Folha de Conjunto..... | 18 | SAM_41 : Variáveis em BYLAYER..... | 36 |

Sumário

| | |
|--|----|
| SAM_42 : Símbolo de Acabamento..... | 37 |
| SAM_43 : Legenda para folhas A4 e A3 | 38 |



As rotinas de uma forma geral foram nomeadas da seguinte forma *** SAM_XX*** onde SAM (SAMPLE) e XX 0 número.

Isso pode ser modificado a qualquer momento para uma variável possível e de sua preferência o único empecilho é a verificação com as variáveis do AutoCad.

Contorno da Construção em metros - SAM_02

Excel gerando desenho no AutoCad

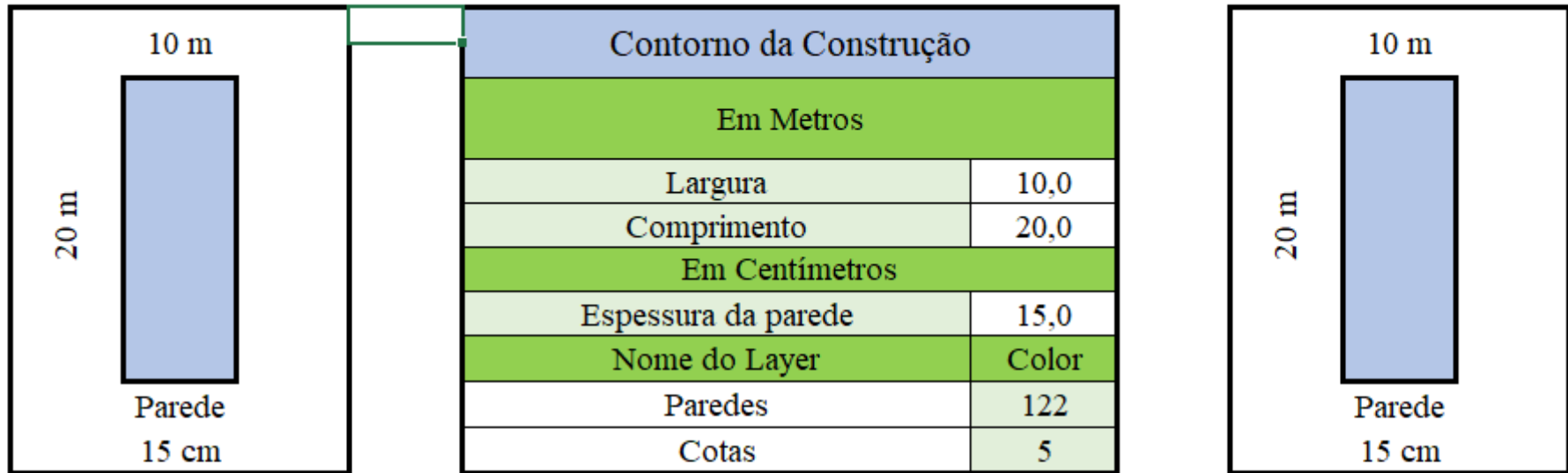

Construção dos Layers Principais - SAM_07

| Layers Gerais | | | |
|---|----------------|-----|------------|
| | Nome do Layer | Cor | Linha |
|  | Paredes | 122 | Continuous |
| | Cotas | 5 | |
| | Texto | 40 | |
| | Legenda | 4 | |
| | Margem Externa | 160 | |
| | Margem Interna | 20 | |
| | Portas | 210 | |
| | Janelas | 150 | |
| | Hachura | 42 | |
| | Tracejado | 3 | |
| | Centro | 10 | Dashdot |

Folha A4 e A3 - SAM_08

Detalhes na Folha



Folha

A4

Esboço da Legenda

Legenda

Existe Sim

Legenda - Número de Linhas

5

Arruelas - SAM_09

|  | | | | Arruelas DIN 125 A | | | |
|---|------|---------|-----------|--------------------|------|---------|-----------|
| Diam | Furo | Externo | Espessura | Diam | Furo | Externo | Espessura |
| M3 | 3,2 | 7,0 | 0,5 | M24 | 25,0 | 44,0 | 4,0 |
| M4 | 4,3 | 9,0 | 0,8 | M27 | 28,0 | 50,0 | 4,0 |
| M5 | 5,3 | 10,0 | 1,0 | M30 | 31,0 | 56,0 | 4,0 |
| M6 | 6,4 | 12,0 | 1,6 | M33 | 34,0 | 60,0 | 5,0 |
| M8 | 8,4 | 16,0 | 1,6 | M36 | 37,0 | 66,0 | 5,0 |
| M10 | 10,5 | 20,0 | 2,0 | M39 | 40,0 | 72,0 | 6,0 |
| M12 | 13,0 | 24,0 | 2,5 | M42 | 43,0 | 78,0 | 7,0 |
| M14 | 15,0 | 28,0 | 2,5 | M45 | 46,0 | 85,0 | 7,0 |
| M16 | 17,0 | 30,0 | 3,0 | M48 | 50,0 | 92,0 | 8,0 |
| M18 | 19,0 | 34,0 | 3,0 | M52 | 54,0 | 98,0 | 8,0 |
| M20 | 21,0 | 37,0 | 3,0 | M56 | 58,0 | 105,0 | 9,0 |
| M22 | 23,0 | 39,0 | 3,0 | M60 | 62,0 | 110,0 | 9,0 |

Círculos - SAM_10

Círculos Concêntricos



| | Diâmetros |
|---|-----------|
| 1 | 10,5 |
| 2 | 18,0 |
| 3 | 20,0 |
| 4 | 25,0 |

Número de Círculos

4

Parafusos - SAM_11

| DIN 912 Parafusos Tipo Allen | | | | | | | |
|------------------------------|-------|--------------|-------------|-------------------------|---------------------------------|-----|-----|
| Diam | Passo | Cabeça | | Rosca Total (máximo) | Comprimentos Normalizados (c) | | |
| | | Diâmetro (D) | Largura (k) | | | | |
| M3 | 0,50 | 5,5 | 3,0 | 20 | 6 | 65 | 190 |
| M4 | 0,70 | 7,0 | 4,0 | 25 | 8 | 70 | 200 |
| M5 | 0,80 | 8,5 | 5,0 | 25 | 10 | 75 | 210 |
| M6 | 1,00 | 10,0 | 6,0 | 30 | 12 | 80 | 220 |
| M8 | 1,25 | 13,0 | 8,0 | 35 | 16 | 90 | 230 |
| M10 | 1,50 | 16,0 | 10,0 | 40 | 20 | 100 | 240 |
| M12 | 1,75 | 18,0 | 12,0 | 45 | 25 | 110 | 250 |
| M14 | 2,00 | 21,0 | 14,0 | 55 | 30 | 120 | 260 |
| M16 | 2,00 | 24,0 | 16,0 | 55 | 35 | 130 | 280 |
| M20 | 2,50 | 30,0 | 20,0 | 65 | 40 | 140 | 300 |
| M24 | 3,00 | 36,0 | 24,0 | 80 | 45 | 150 | 320 |
| M30 | 3,00 | 45,0 | 30,0 | 90 | 50 | 160 | 340 |
| M36 | 4,00 | 54,0 | 36,0 | 100 | 55 | 170 | 360 |
| M42 | 4,50 | 63,0 | 42,0 | 120 | 60 | 180 | 380 |

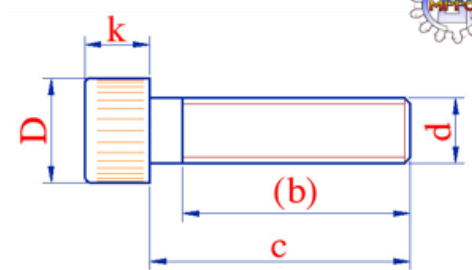

Digitar o comprimento (c)
35

Digitar o comprimento roscado (b)
25

Rebaixo - SAM_12

Rebaixo para parafusos Tipo Allen - DIN 74

| | Diâmetro Menor | Diâmetro Menor Fino | Diâmetro Maior | Altura da Cabeça |
|-----|----------------|---------------------|----------------|------------------|
| M3 | 3,4 | 3,3 | 6,5 | 4,5 |
| M4 | 4,4 | 4,3 | 8,5 | 5,5 |
| M5 | 5,5 | 5,3 | 10,0 | 7,0 |
| M6 | 6,6 | 6,4 | 11,0 | 8,5 |
| M8 | 9,0 | 8,4 | 15,0 | 11,0 |
| M10 | 11,0 | 10,5 | 18,0 | 13,5 |
| M12 | 14,0 | 13,0 | 20,0 | 16,0 |
| M14 | 16,0 | 15,0 | 23,0 | 18,0 |
| M16 | 18,0 | 17,0 | 26,0 | 21,0 |
| M20 | 22,0 | 21,0 | 33,0 | 25,5 |
| M24 | 26,0 | 25,0 | 40,0 | 30,5 |
| M30 | 33,0 | 32,0 | 48,0 | 38,0 |
| M36 | 39,0 | 38,0 | 57,0 | 44,0 |
| M42 | 45,0 | 44,0 | 66,0 | 52,0 |

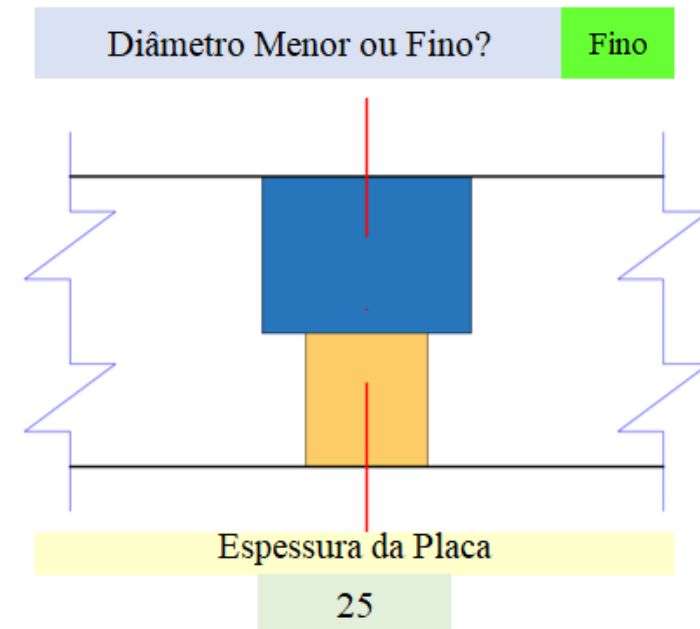

Indicação de Corte - SAM_13

Corte por planos paralelos



| | |
|----------------------|-----|
| Comprimento da Linha | 8,0 |
| Espessura da Linha | 0,8 |

EA DA

E D

Porcas - SAM_14

Porcas DIN 934

| | Passo | Chave | Espessura | Ang ° | (Ref) |
|-----|-------|-------|-----------|-------|-------|
| M3 | 0,50 | 5,0 | 2,4 | 30 | 4,9 |
| M4 | 0,70 | 7,0 | 3,2 | 30 | 6,9 |
| M5 | 0,80 | 8,0 | 4,0 | 30 | 7,9 |
| M6 | 1,00 | 10,0 | 5,0 | 30 | 9,8 |
| M8 | 1,25 | 13,0 | 6,5 | 30 | 12,7 |
| M10 | 1,50 | 17,0 | 8,0 | 30 | 16,7 |
| M12 | 1,75 | 19,0 | 10,0 | 30 | 18,5 |
| M14 | 2,00 | 22,0 | 11,0 | 30 | 21,6 |
| M16 | 2,00 | 24,0 | 13,0 | 30 | 23,4 |
| M20 | 2,50 | 30,0 | 16,0 | 30 | 29,2 |
| M24 | 3,00 | 36,0 | 19,0 | 30 | 35,1 |
| M30 | 3,00 | 46,0 | 24,0 | 30 | 44,5 |
| M36 | 4,00 | 55,0 | 29,0 | 30 | 53,5 |
| M42 | 4,50 | 65,0 | 34,0 | 30 | 63,5 |

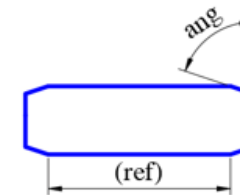
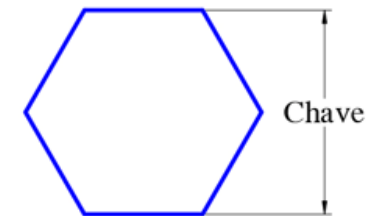

Furos Roscados - SAM_15

Furos Roscados

| Diam | Passo | Diâmetro | Furo |
|------|-------|----------|------|
| M3 | 0,50 | 3 | 2,5 |
| M4 | 0,70 | 4 | 3,3 |
| M5 | 0,80 | 5 | 4,2 |
| M6 | 1,00 | 6 | 5,0 |
| M8 | 1,25 | 8 | 6,8 |
| M10 | 1,50 | 10 | 8,5 |
| M12 | 1,75 | 12 | 10,2 |
| M14 | 2,00 | 14 | 12,0 |
| M16 | 2,00 | 16 | 14,0 |
| M20 | 2,50 | 20 | 17,5 |
| M24 | 3,00 | 24 | 21,0 |
| M30 | 3,50 | 30 | 26,5 |
| M36 | 4,00 | 36 | 32,0 |
| M42 | 4,50 | 42 | 37,5 |

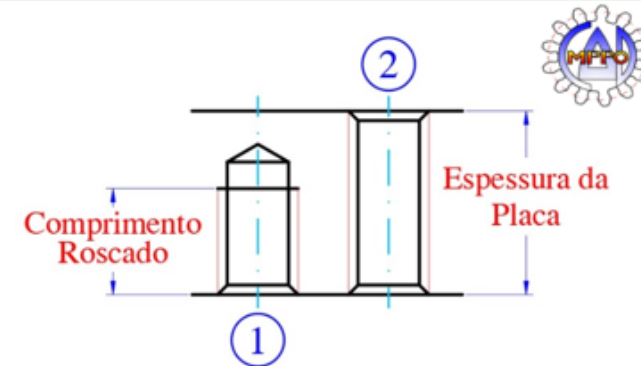

Comprimento Roscado

20,0

Tipo de Furo

2

O comprimento roscado é a espessura da placa.

Esboço de Eixos - SAM_16

| Corpo | Diâmetro | Comprimento | Digitar os valores |
|-------|----------|-------------|--------------------|
| 1 | 25,00 | 40,00 | Correto |
| 2 | 20,00 | 28,00 | Correto |
| 3 | 32,00 | 30,00 | Correto |
| 4 | 38,00 | 3,00 | Correto |
| 5 | 55,00 | 32,00 | Correto |
| 6 | 38,00 | 3,00 | Correto |
| 7 | 32,00 | 40,00 | Correto |
| 8 | 65,00 | 16,00 | Correto |
| 9 | 30,00 | 8,00 | Correto |
| 10 | 24,00 | 30,00 | Correto |

Comprimento Total do Eixo

230,00
unidades

Número de Corpos

10

Sketch para SolidWorks - SAM_17



Esboço de Eixos no Autocad

| Corpo | Diâmetro | Comprimento | Digitar os valores |
|-------|----------|-------------|--------------------|
| 1 | 25,00 | 40,00 | Correto |
| 2 | 20,00 | 28,00 | Correto |
| 3 | 32,00 | 30,00 | Correto |
| 4 | 38,00 | 3,00 | Correto |
| 5 | 55,00 | 32,00 | Correto |
| 6 | 38,00 | 3,00 | Correto |
| 7 | 32,00 | 40,00 | Correto |
| 8 | 65,00 | 16,00 | Correto |
| 9 | 30,00 | 8,00 | Correto |
| 10 | 24,00 | 30,00 | Correto |

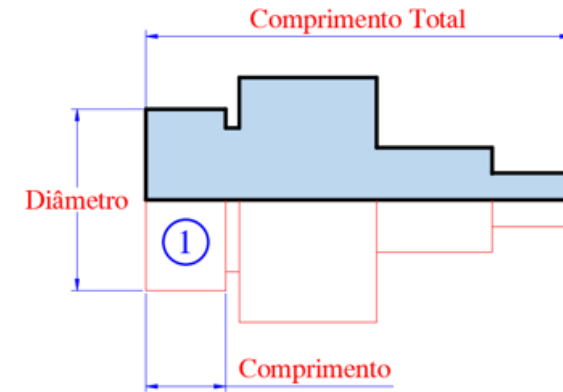

Comprimento Total do Eixo

230,00

unidades

Número de Corpos

10

Furos - SAM_18

Furos para passagem de parafusos roscados

| Diam | Passo | Diâmetro |
|------|-------|----------|
| M3 | 0,50 | 3,3 |
| M4 | 0,70 | 4,3 |
| M5 | 0,80 | 5,5 |
| M6 | 1,00 | 6,5 |
| M8 | 1,25 | 8,5 |
| M10 | 1,50 | 10,5 |
| M12 | 1,75 | 12,5 |
| M14 | 2,00 | 14,5 |
| M16 | 2,00 | 16,5 |
| M20 | 2,50 | 21,0 |
| M24 | 3,00 | 25,0 |
| M30 | 3,00 | 31,0 |
| M36 | 4,00 | 37,0 |
| M42 | 4,50 | 43,0 |

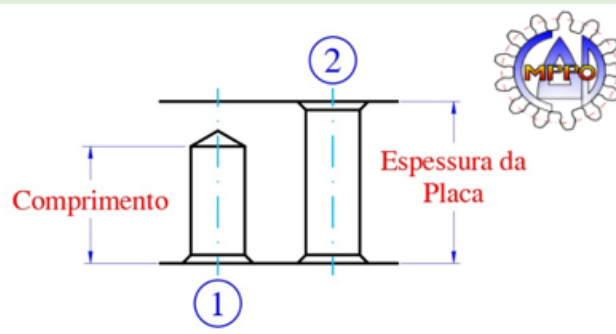

Diâmetro Personalizado Não

Construir Tipo 1

Espessura da Placa
30,0

Comprimento do Furo
30,0

Chanfro a 45°
1,0

Comando CL do AutoCad - Alteração da Linha pela Rotina - SAM_19

Linhas de Centro Laterais

Comando CL no AutoCad

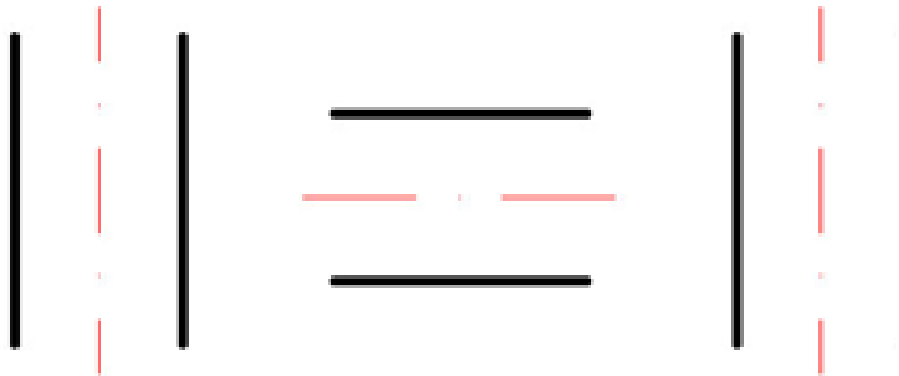

Linha de Centro Dashdot - SAM_20

Linhas de Centro circulares

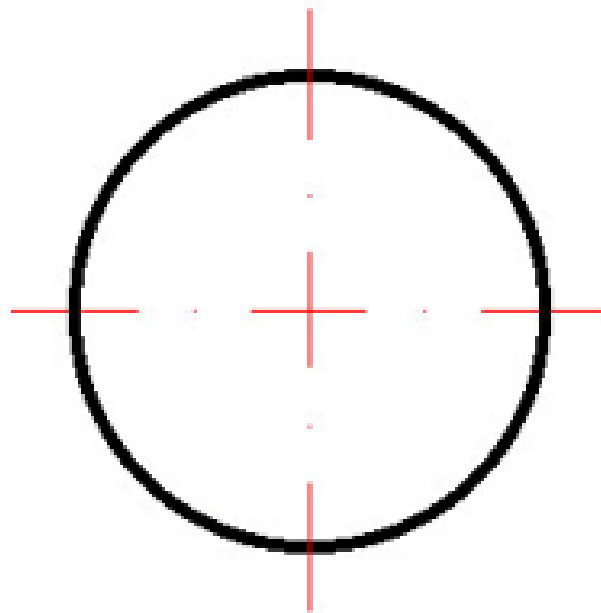

Lâmpadas Simbologia

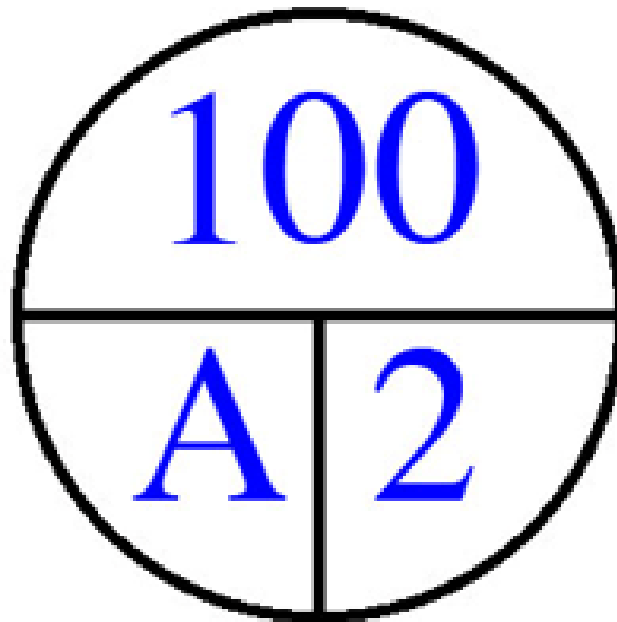

Numeração na Folha de Detalhes - SAM_22

Numeração de Montagem

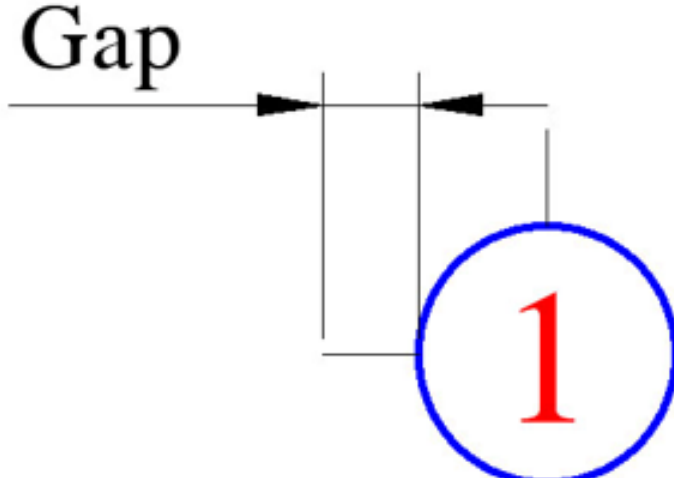

| | |
|-----------------------|------|
| Diâmetro do Círculo | 10,0 |
| Altura do Texto | 5,0 |
| Gap de Inserção (x y) | 1,0 |

Desenho de Montagem - SAM_23

Numeração de Montagem

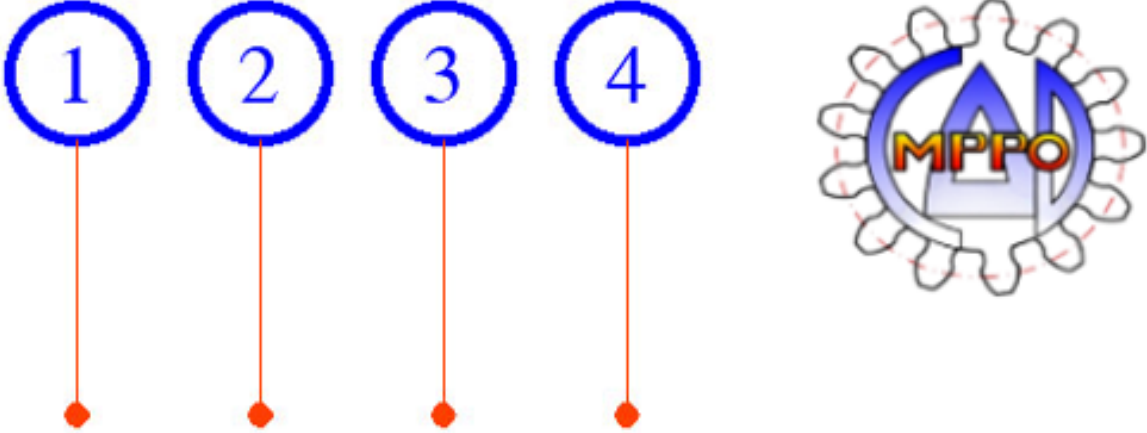

| | |
|----------------------|------|
| Diâmetro do Círculo | 10,0 |
| Altura do Texto | 5,0 |
| Diâmetro de Inserção | 1,0 |

Array Polar - SAM_24

Array Polar Simplificado

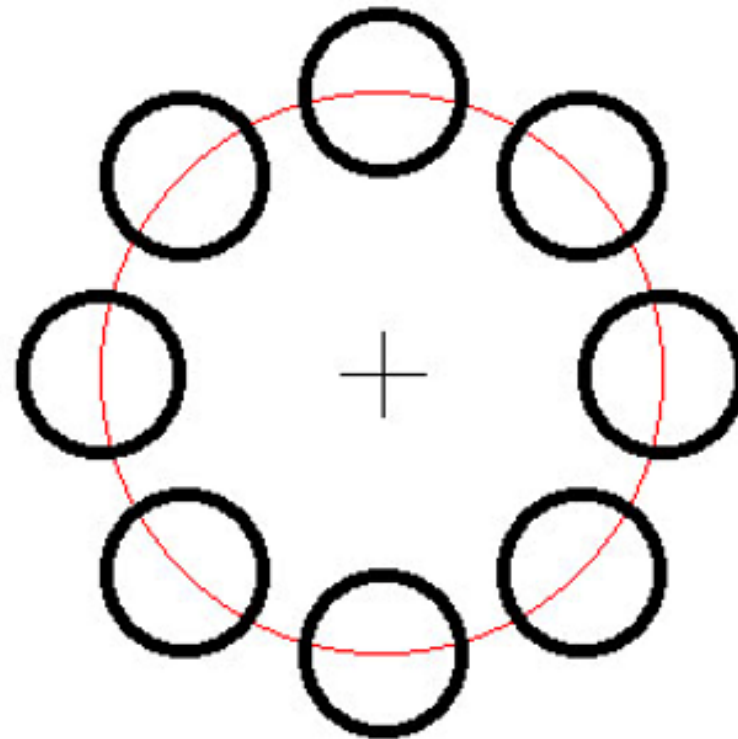

Array Retangular - SAM_25

Array Retangular Simplificado

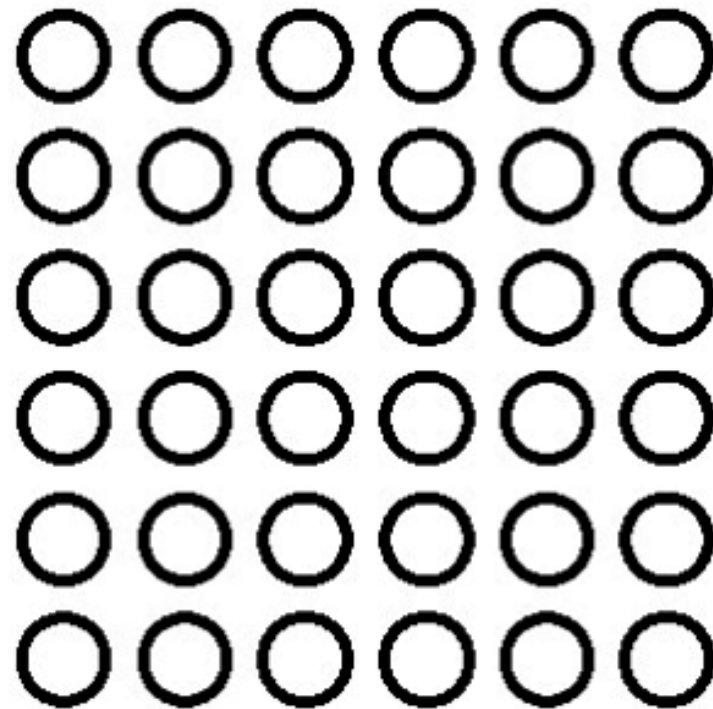

Chavetas - SAM_26

DIN 6885 A Chavetas



| | | |
|-------------------------|------|----------|
| Chaveta Escolhida ID | N 15 | |
| Diâmetro do Eixo | 7 | 95 a 110 |
| Comprimento Normalizado | 180 | |

| ID | Diâmetro | | Largura b | Altura h | Eixo t1 | Cubo t2 | Comprimentos Normalizados | |
|-----|----------|-----|--------------|-------------|------------|------------|---------------------------|-----|
| | Acima | Até | | | | | | |
| N1 | 6 | 8 | 2 | 2 | 1,2 | 1,0 | 6 | 180 |
| N2 | 8 | 10 | 3 | 3 | 1,8 | 1,4 | 8 | 200 |
| N3 | 10 | 12 | 4 | 4 | 2,5 | 1,8 | 10 | 220 |
| N4 | 12 | 17 | 5 | 5 | 3,0 | 2,3 | 12 | 250 |
| N5 | 17 | 22 | 6 | 6 | 3,5 | 2,8 | 14 | 280 |
| N6 | 22 | 30 | 8 | 7 | 4,0 | 3,3 | 16 | 320 |
| N7 | 30 | 38 | 10 | 8 | 5,0 | 3,3 | 18 | 360 |
| N8 | 38 | 44 | 12 | 8 | 5,0 | 3,3 | 20 | 400 |
| N9 | 44 | 50 | 14 | 9 | 5,5 | 3,8 | 22 | |
| N10 | 50 | 58 | 16 | 10 | 6,0 | 4,3 | 25 | |
| N11 | 58 | 65 | 18 | 11 | 7,0 | 4,4 | 28 | |

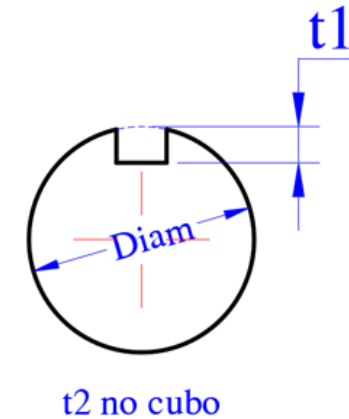
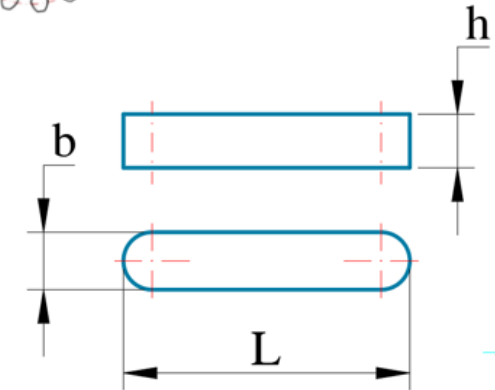

Furos Roscados Vista Superior - SAM_27

| Furos Roscados | | | |
|----------------|-------|----------|------|
| Diam | Passo | Diâmetro | Furo |
| M3 | 0,50 | 3 | 2,5 |
| M4 | 0,70 | 4 | 3,3 |
| M5 | 0,80 | 5 | 4,2 |
| M6 | 1,00 | 6 | 5,0 |
| M8 | 1,25 | 8 | 6,8 |
| M10 | 1,50 | 10 | 8,5 |
| M12 | 1,75 | 12 | 10,2 |
| M14 | 2,00 | 14 | 12,0 |
| M16 | 2,00 | 16 | 14,0 |
| M20 | 2,50 | 20 | 17,5 |
| M24 | 3,00 | 24 | 21,0 |
| M30 | 3,50 | 30 | 26,5 |
| M36 | 4,00 | 36 | 32,0 |
| M42 | 4,50 | 42 | 37,5 |

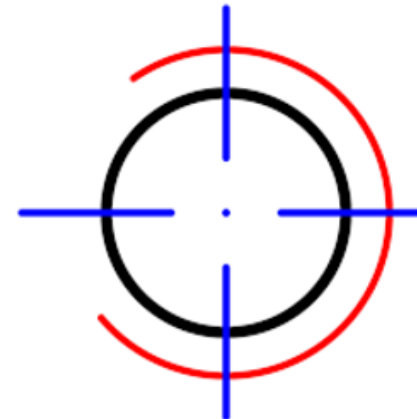

Rolamento Fixo de Esferas - Vide catálogo Fag - SAM_28

Rolamento Fixo de Esferas - Catálogo FAG

| | |
|---|-------|
| Diâmetro do Eixo (d) | 50,0 |
| Diâmetro Externo (D) | 90,0 |
| Alojamento (J) | 62,0 |
| Alojamento (H1) | 77,9 |
| Raio de arredondamento | 2,0 |
| Espessura do Rolamento | 20 |
| Diâmetro da Esfera (calculado e aproximado) | 13,28 |

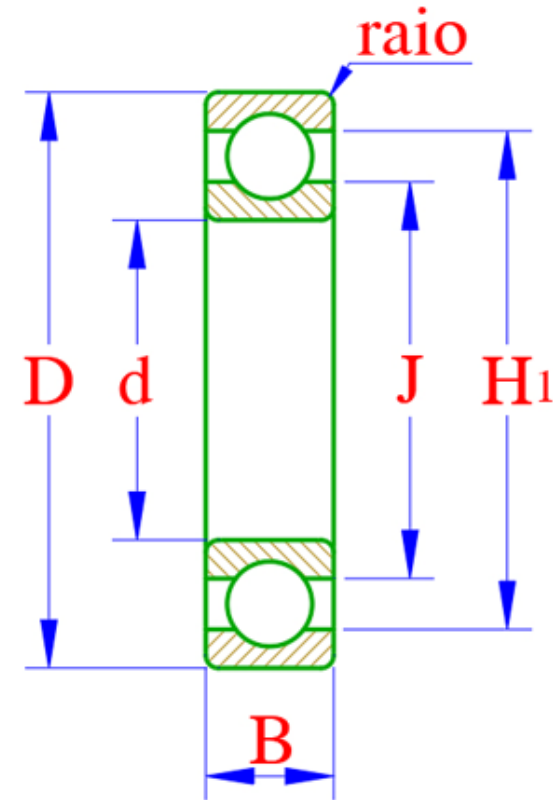

Cálculo do Perímetro - SAM_29

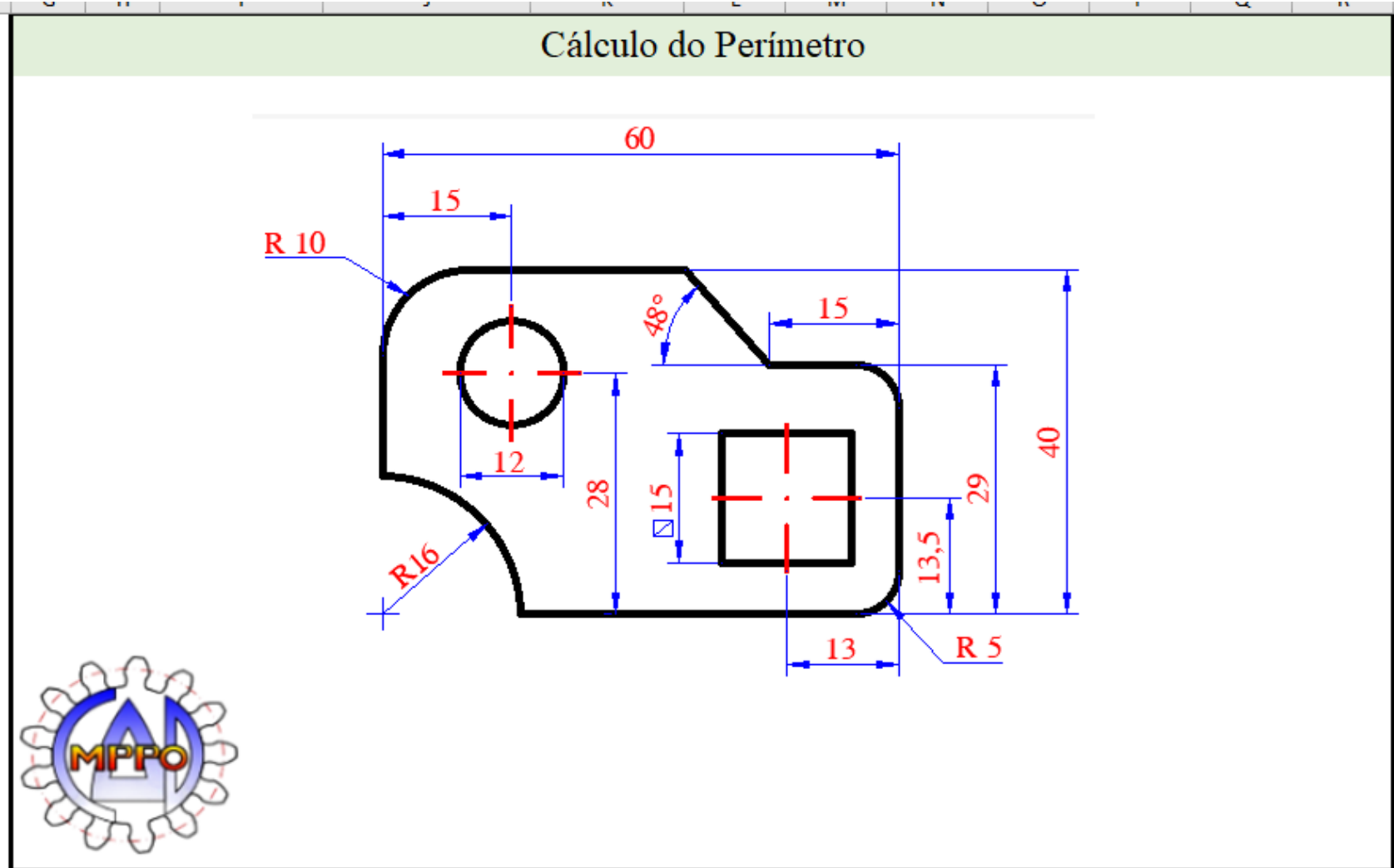

Matriz Quadrada de Círculos - SAM_30

Matriz Quadrada de Círculos

| | |
|----------------------|------|
| Diâmetro do Círculo | 10,0 |
| Entre Círculos - Gap | 2,0 |
| Número de Círculos | 5 |

Diâmetro

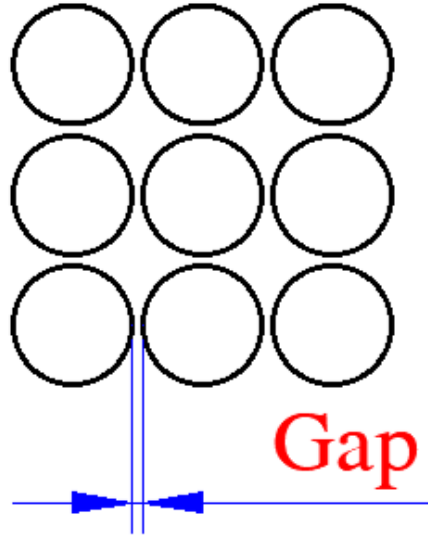

Gap



The diagram illustrates a 3x3 grid of circles. A vertical blue line with arrows at the bottom indicates the diameter of one circle, labeled 'Diâmetro' in red. A horizontal blue line with arrows at the ends indicates the gap between two adjacent circles, labeled 'Gap' in red. The grid consists of 9 circles arranged in 3 rows and 3 columns.

Matriz Quadrada de Linhas - Grade - SAM_31

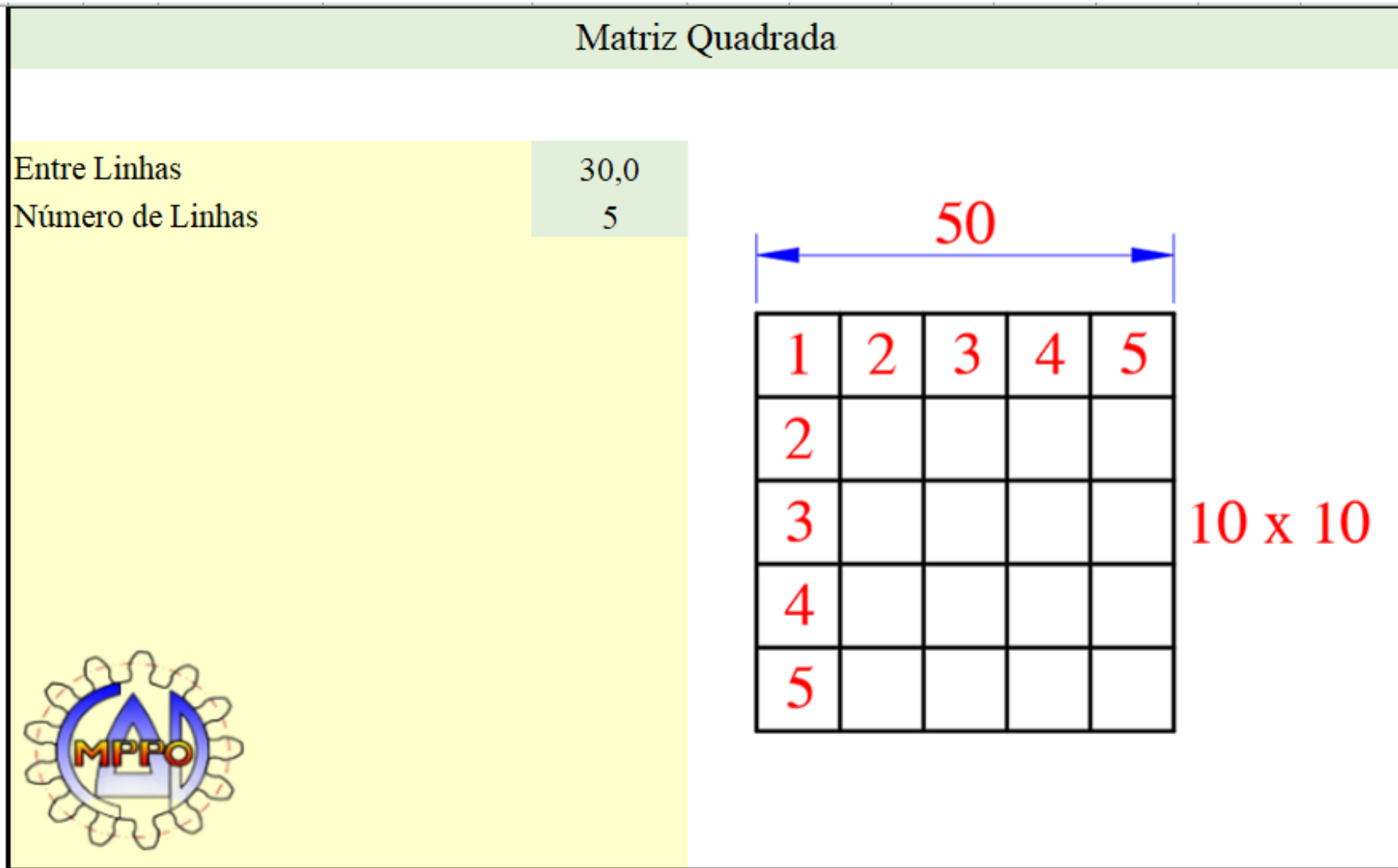

Abertura da Janela - SAM_32

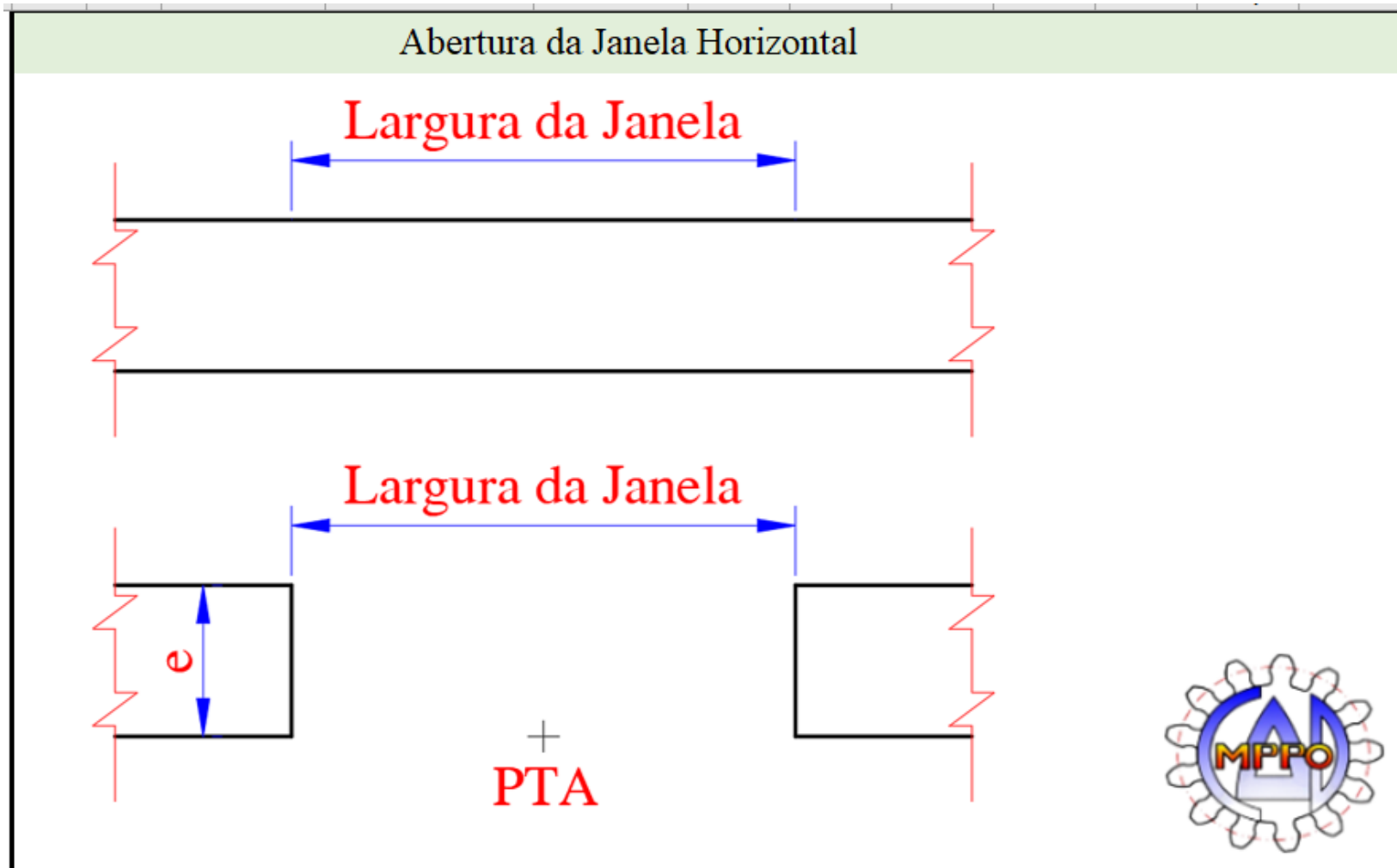

Abertura da Janela - SAM_33

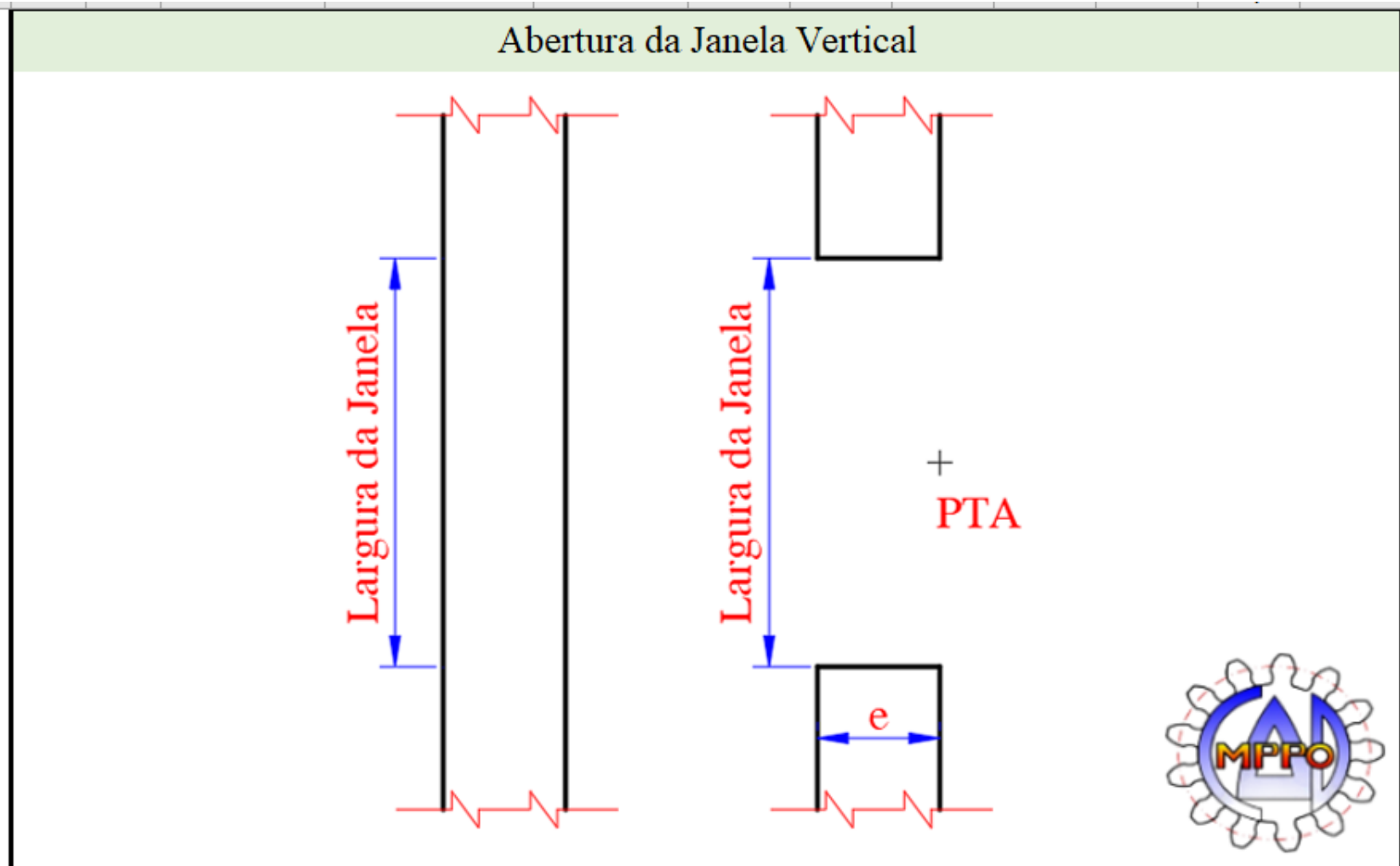

Região da Construção - SAM_34

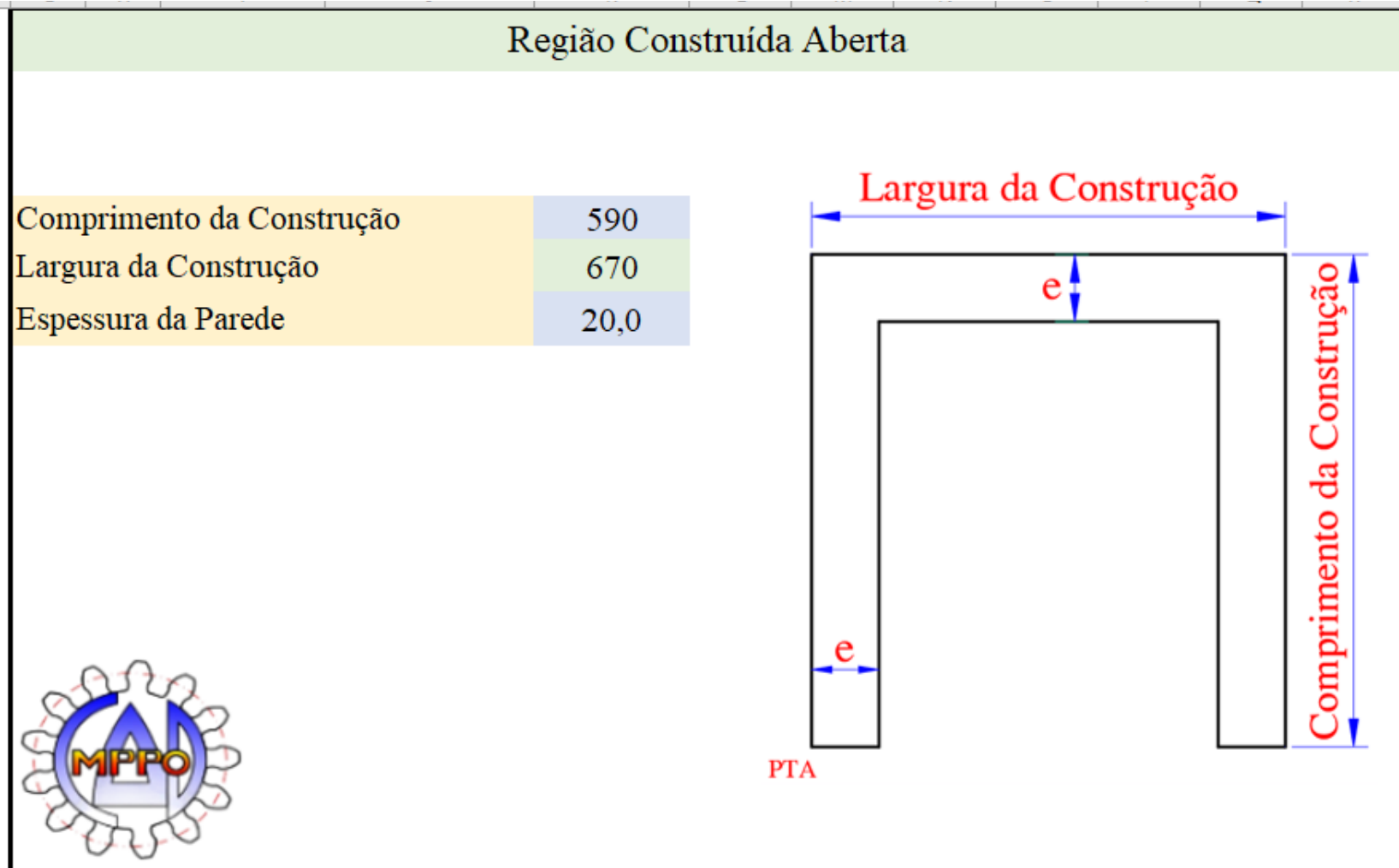

Área da Construção Fechada - SAM_35

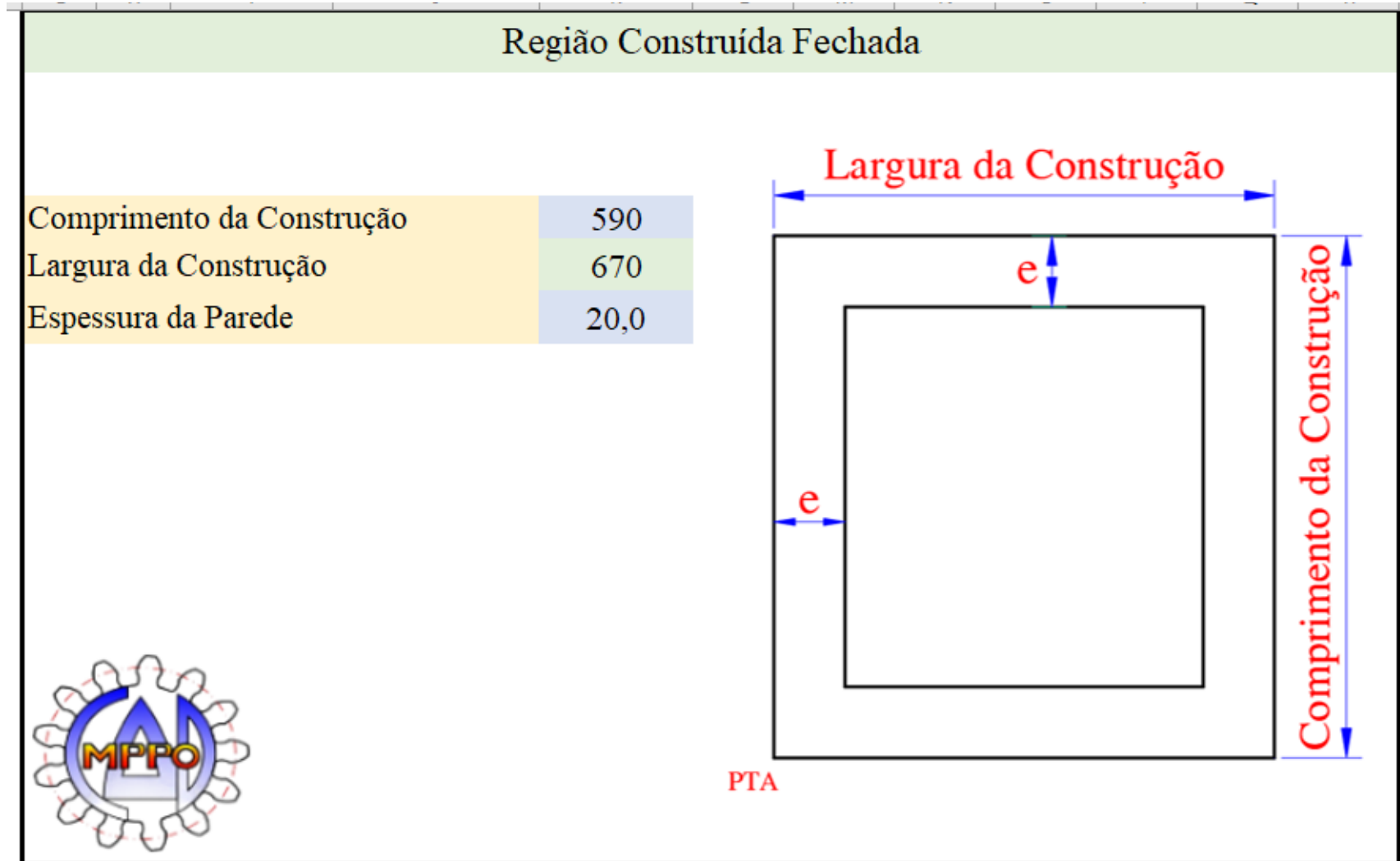

Janela Simplificado Horizontal - SAM_36

Traçado simplificado da Janela

| | |
|---------------------|-------|
| Largura da Janela | 100,0 |
| Fator entre linhas | 10,0 |
| Espessura da Parede | 20,0 |

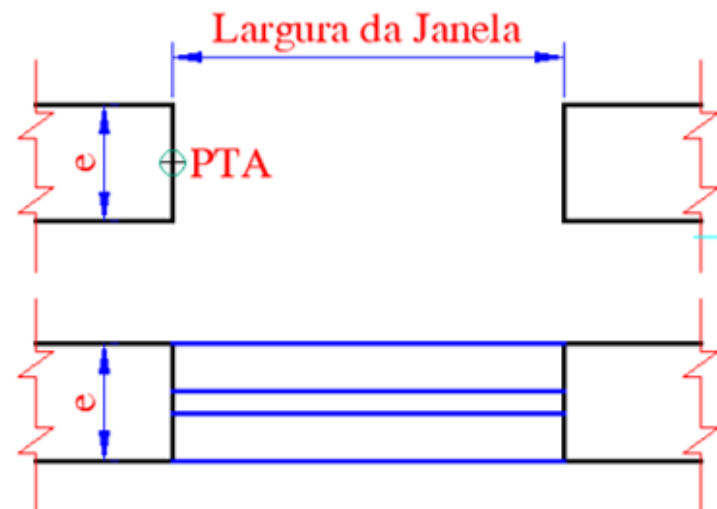

Janela Vertical - SAM_37

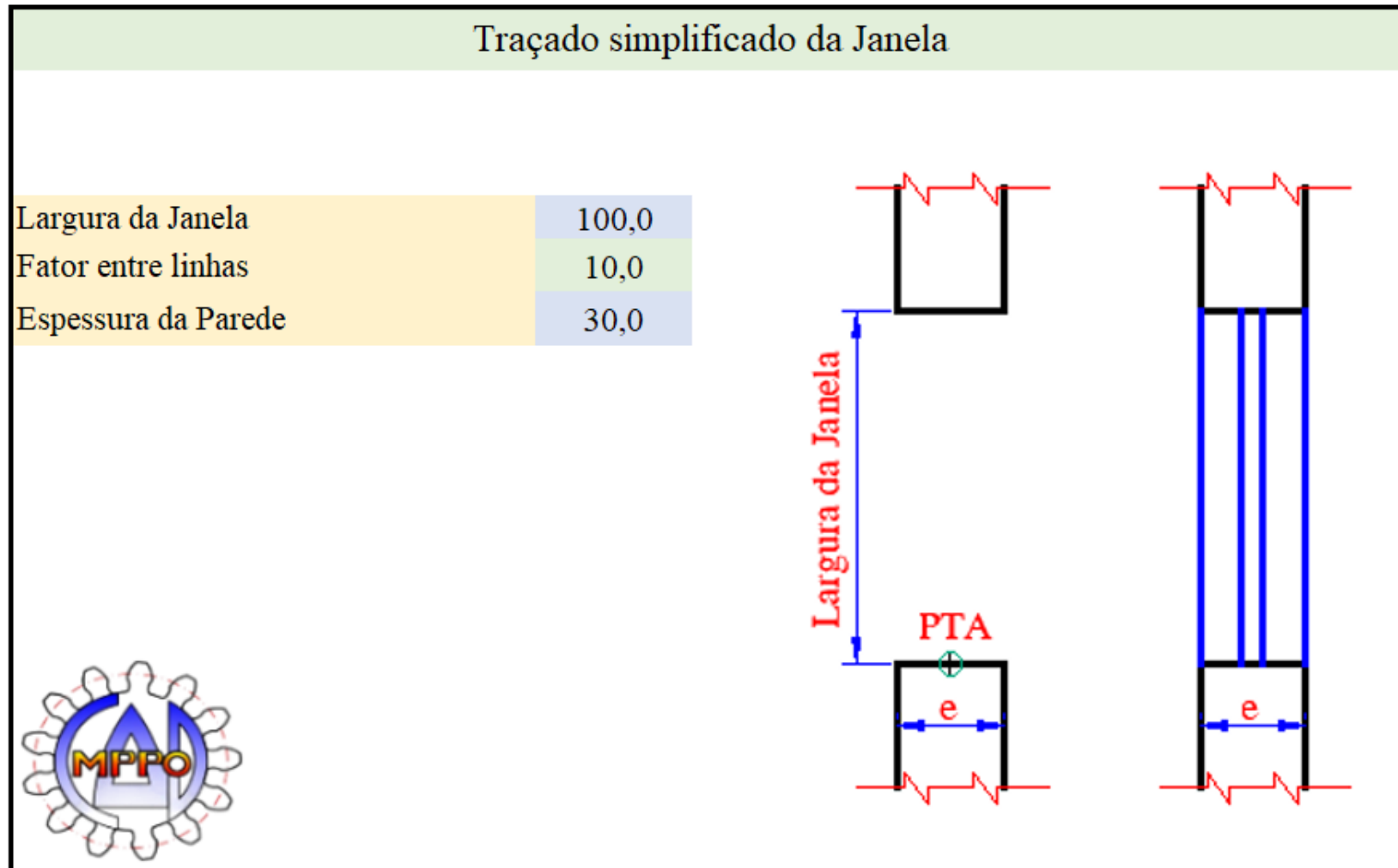

Portas Simplificadas - SAM_38

Traçado simplificado da Porta

| | |
|---------------------------------------|------|
| Abertura da Porta | 80,0 |
| Fator entre linhas - abertura / fator | 20,0 |

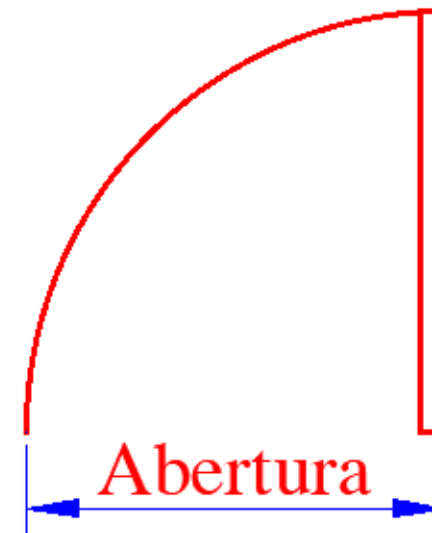

Vão da Porta e Espaleta Horizontal - SAM_39

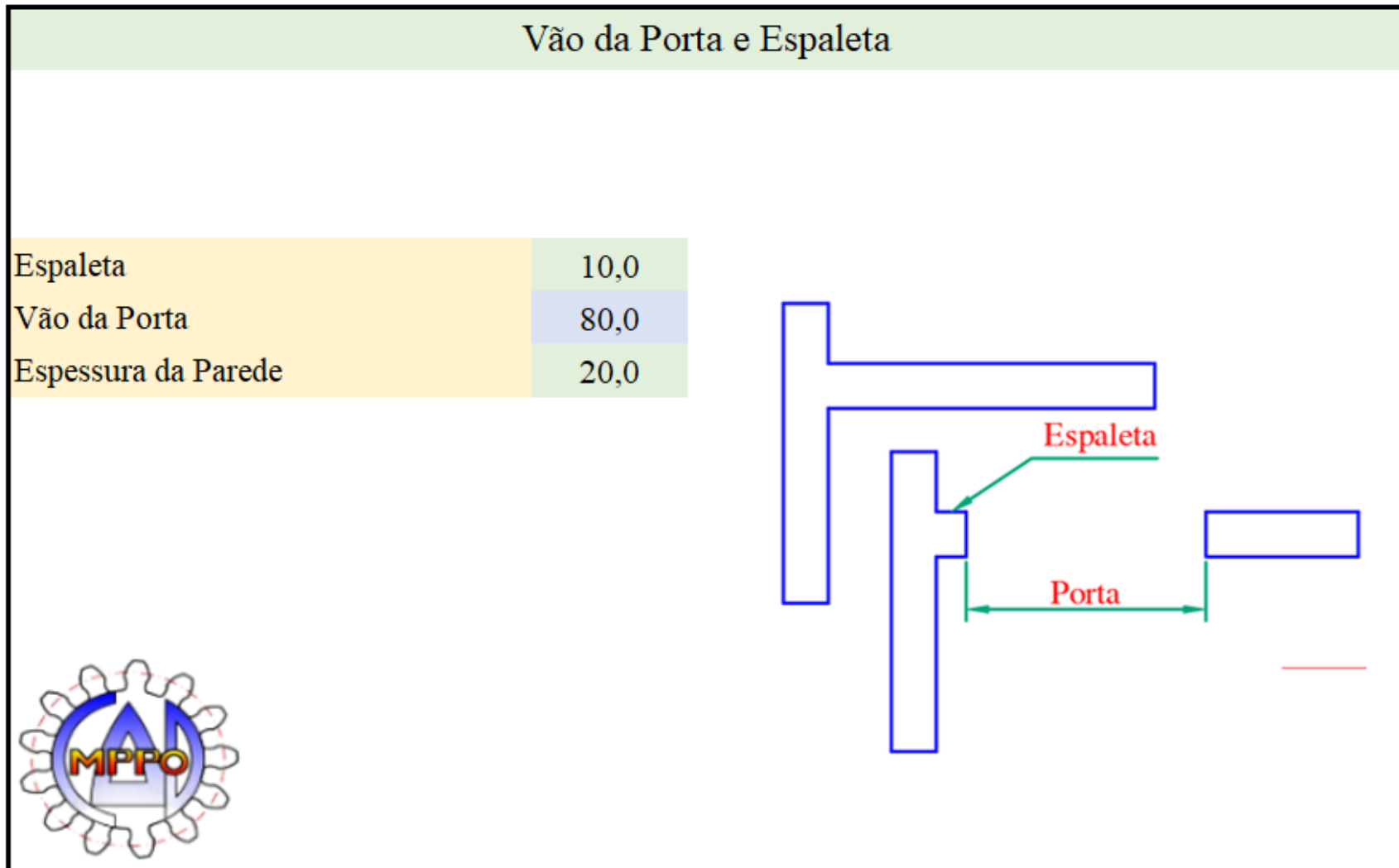

Vão da Porta e Espaleta Vertical - SAM_40

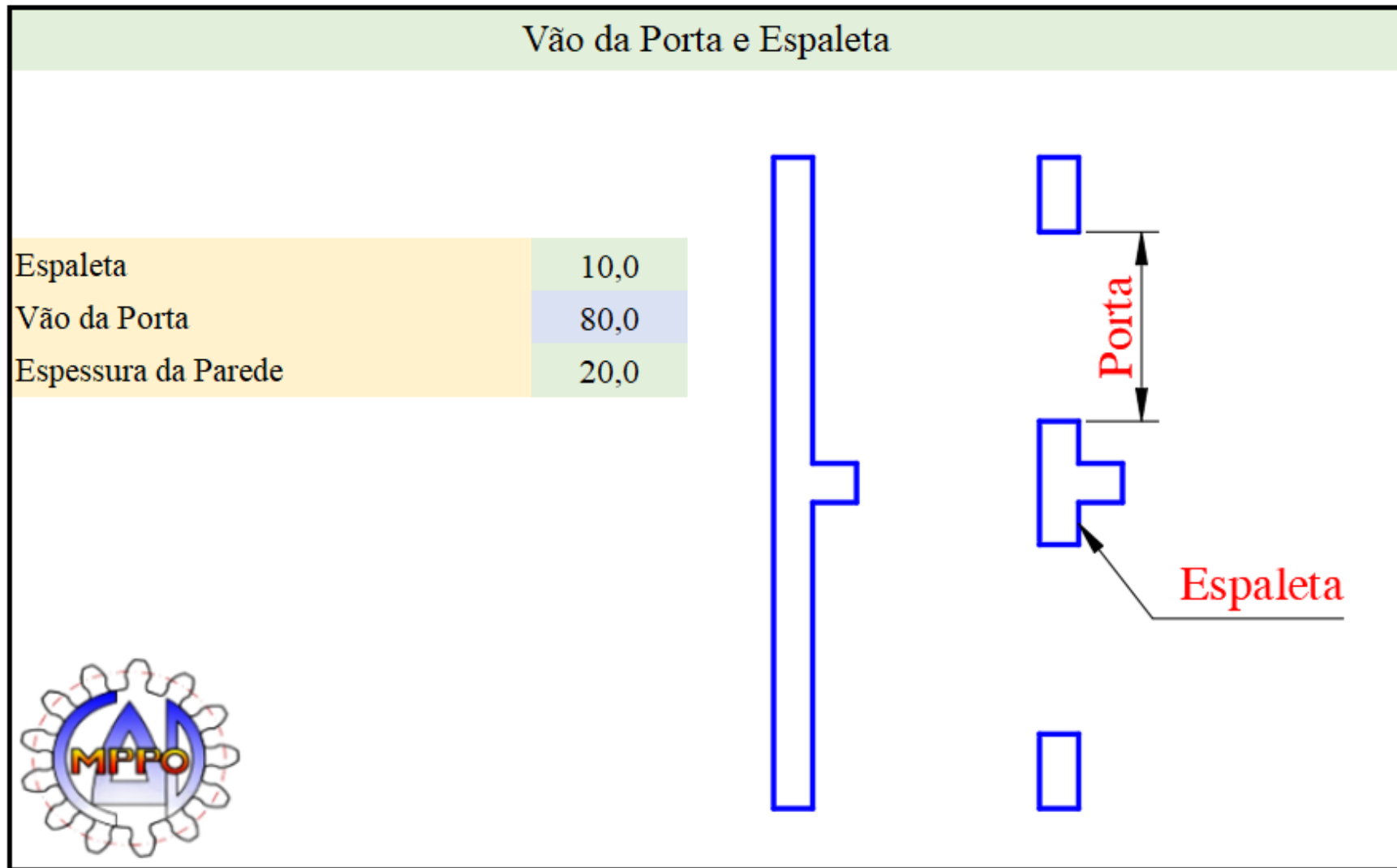

Passagem de objetos individualizados para BYLAYER - SAM_41

Objetos no AutoCad

Para mim os objetos precisam, em um primeiro momento, estarem em layers com a variável BYLAYER. A rotina muda os objetos para BYLAYER.



Símbolo de Acabamento - SAM_42

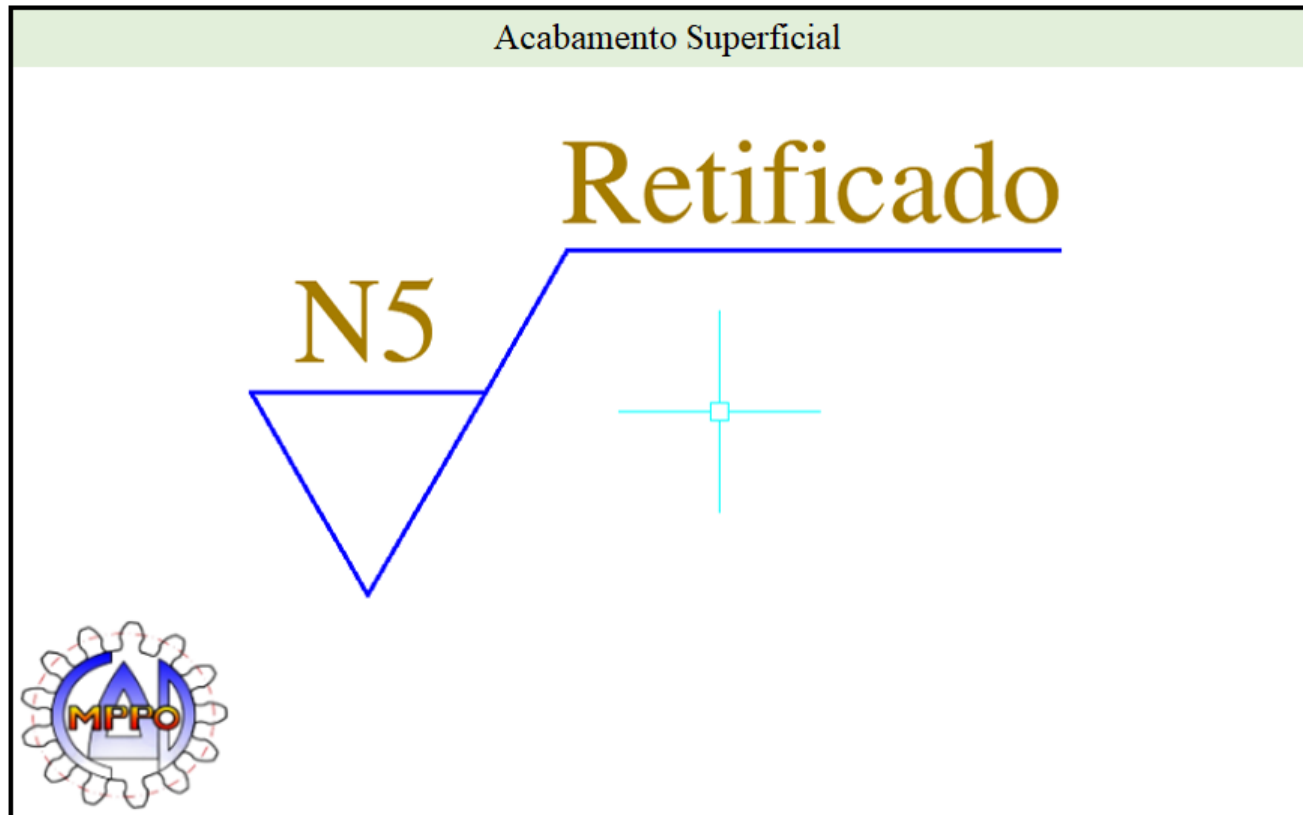

Legenda para Folhas A4 e A3 - SAM_43

Traçado da Legenda - Folha A4 e A3



| | |
|--|-------|
| Largura da Legenda - Folha A4 | 173,0 |
| Entre Linhas | 5,0 |
| Altura do Texto | 3,0 |
| Distância da primeira linha da legenda | 2,0 |



Eixo construído com os dados da planilha excel

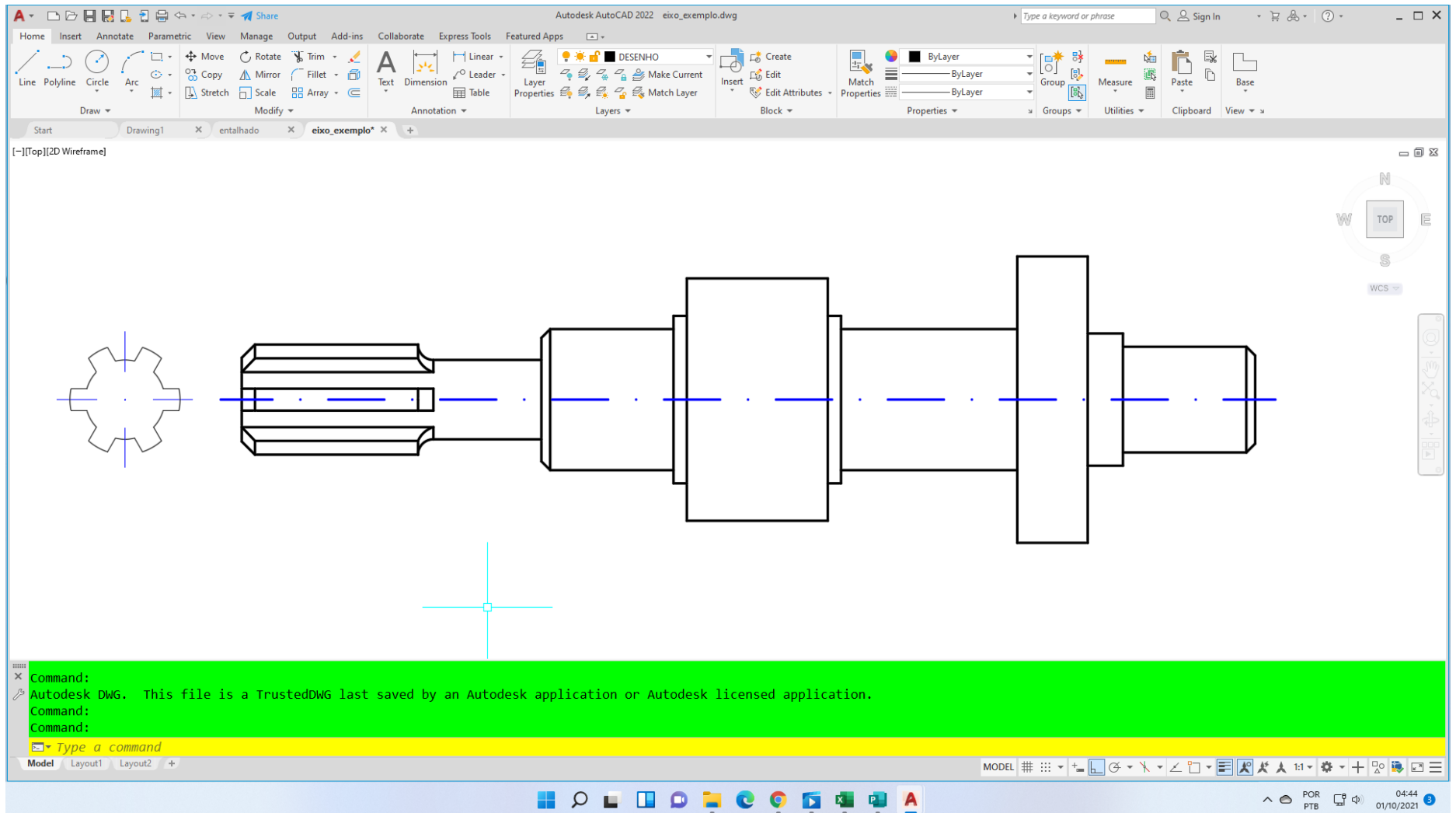

Sketch gerado

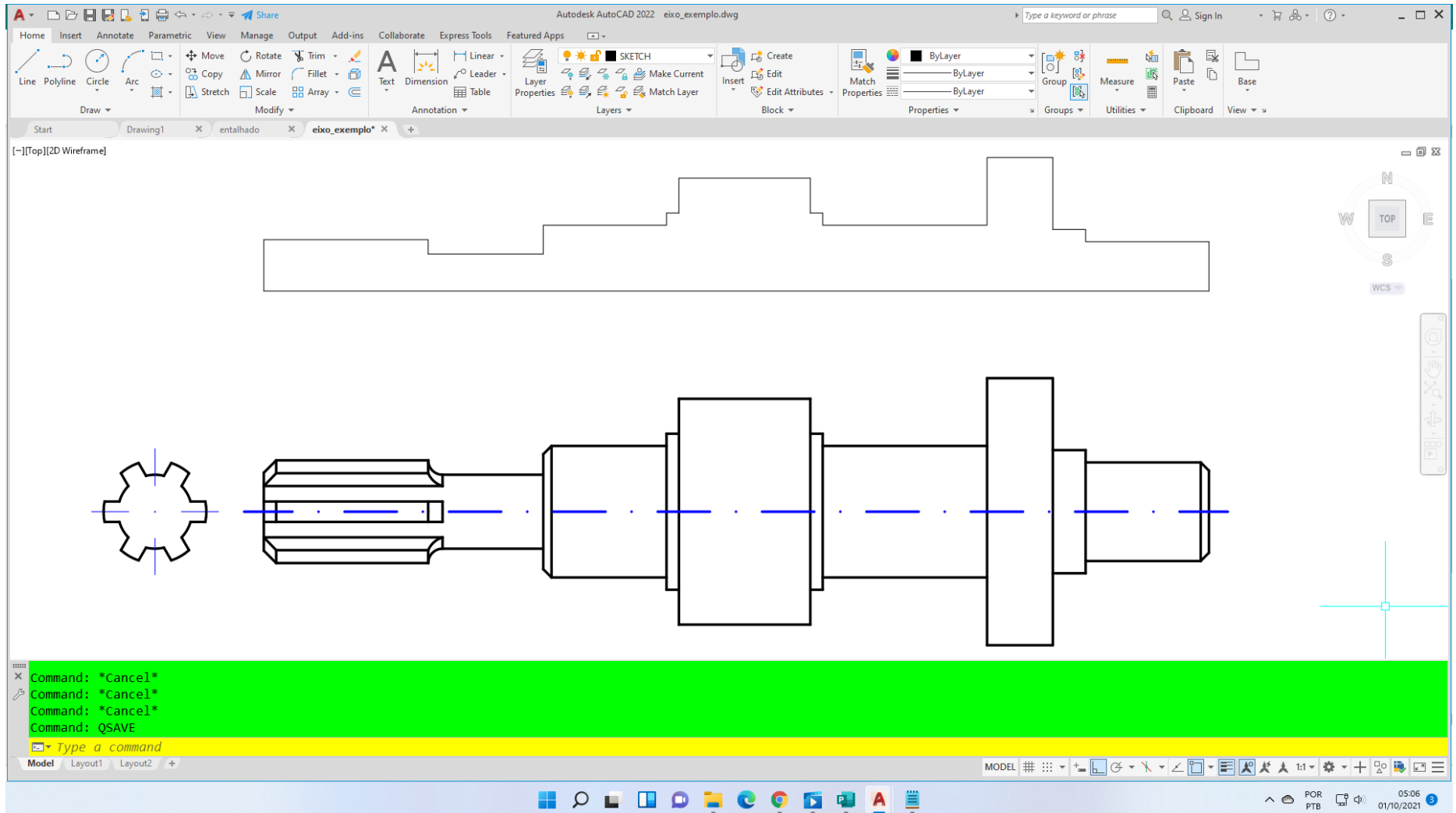

Modelo 3D no AutoCad

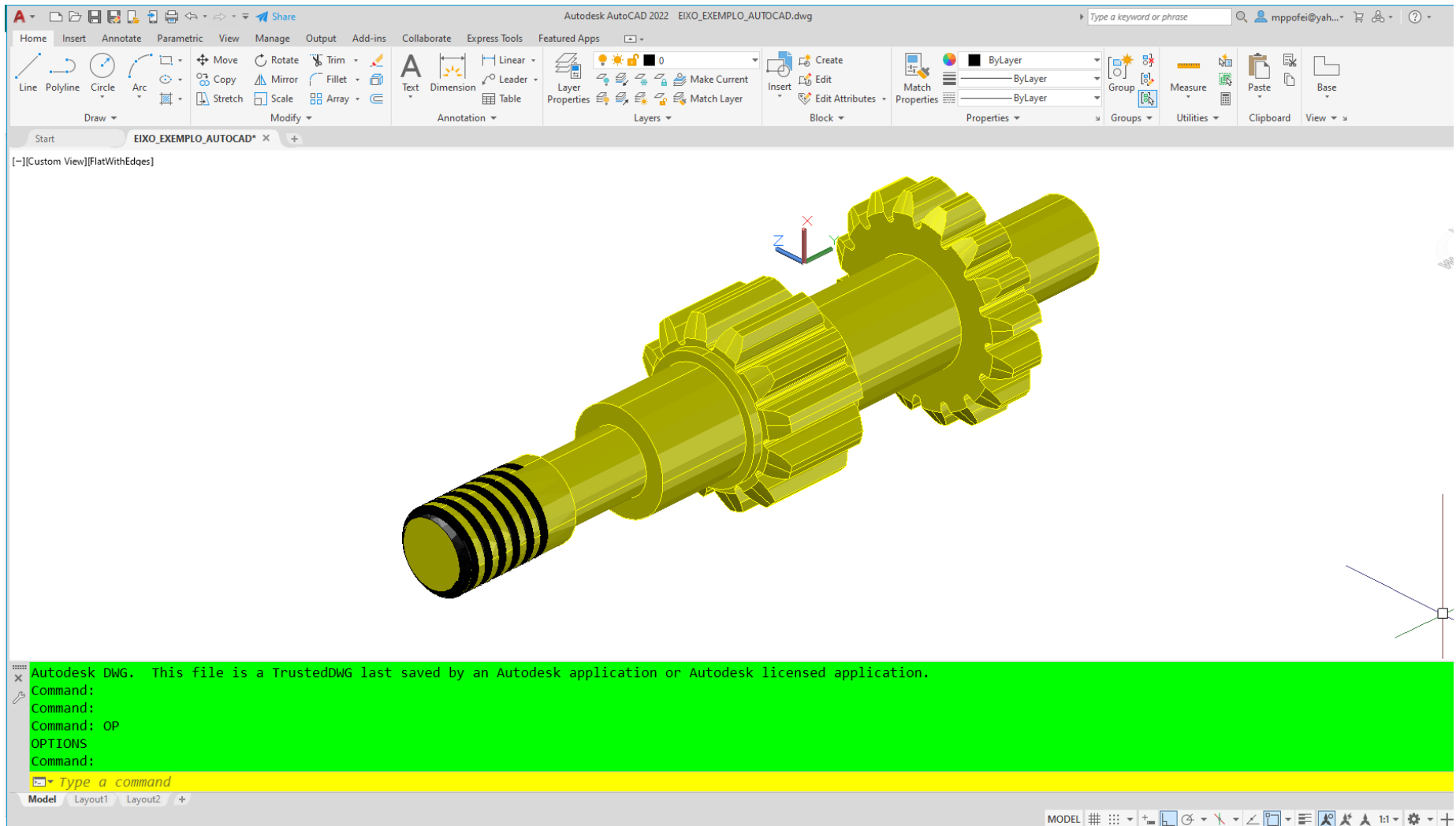

Modelo 3D no SolidWorks

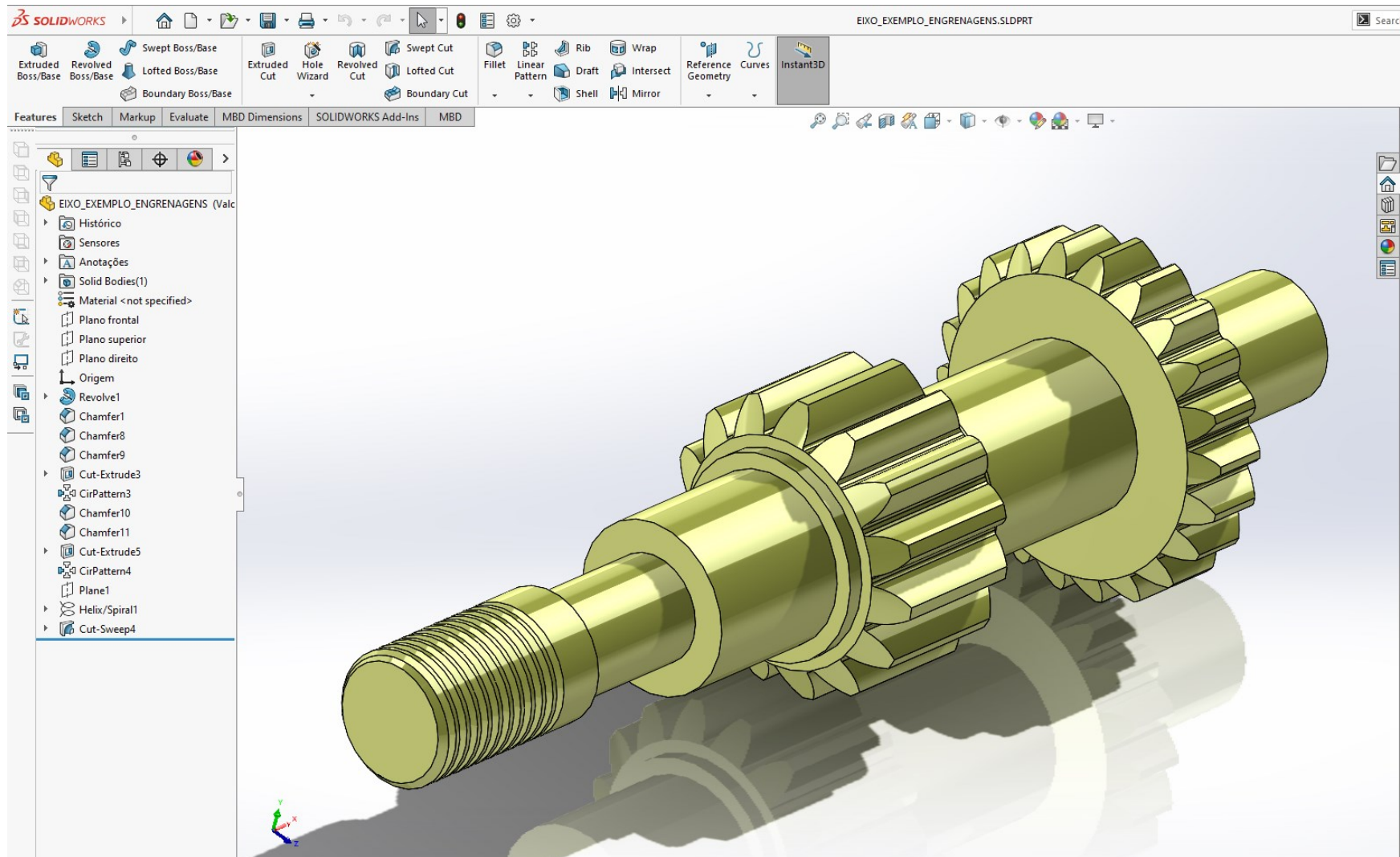

Modelo 3D no SolidWorks

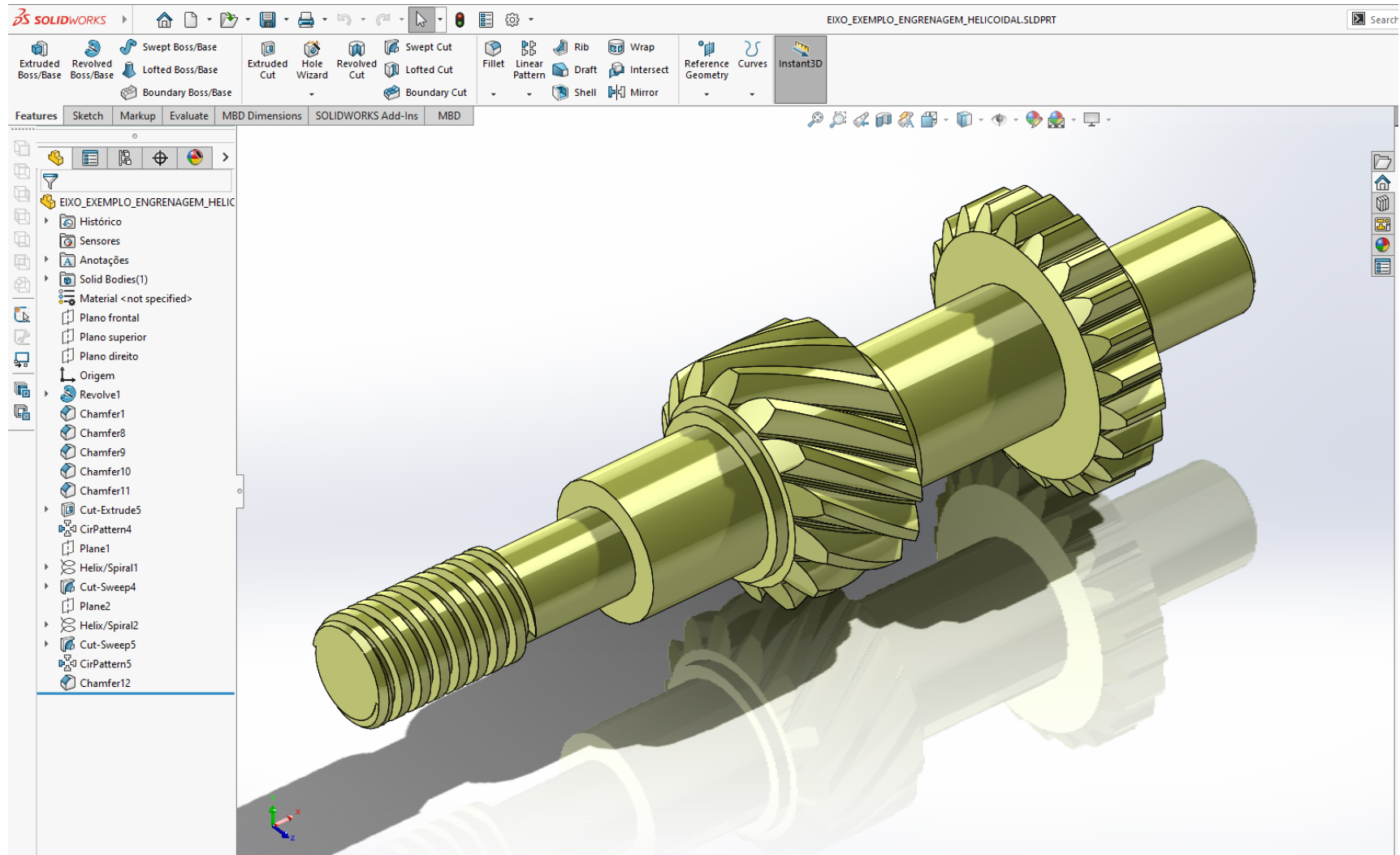

Modelo 3D no Autodesk Inventor

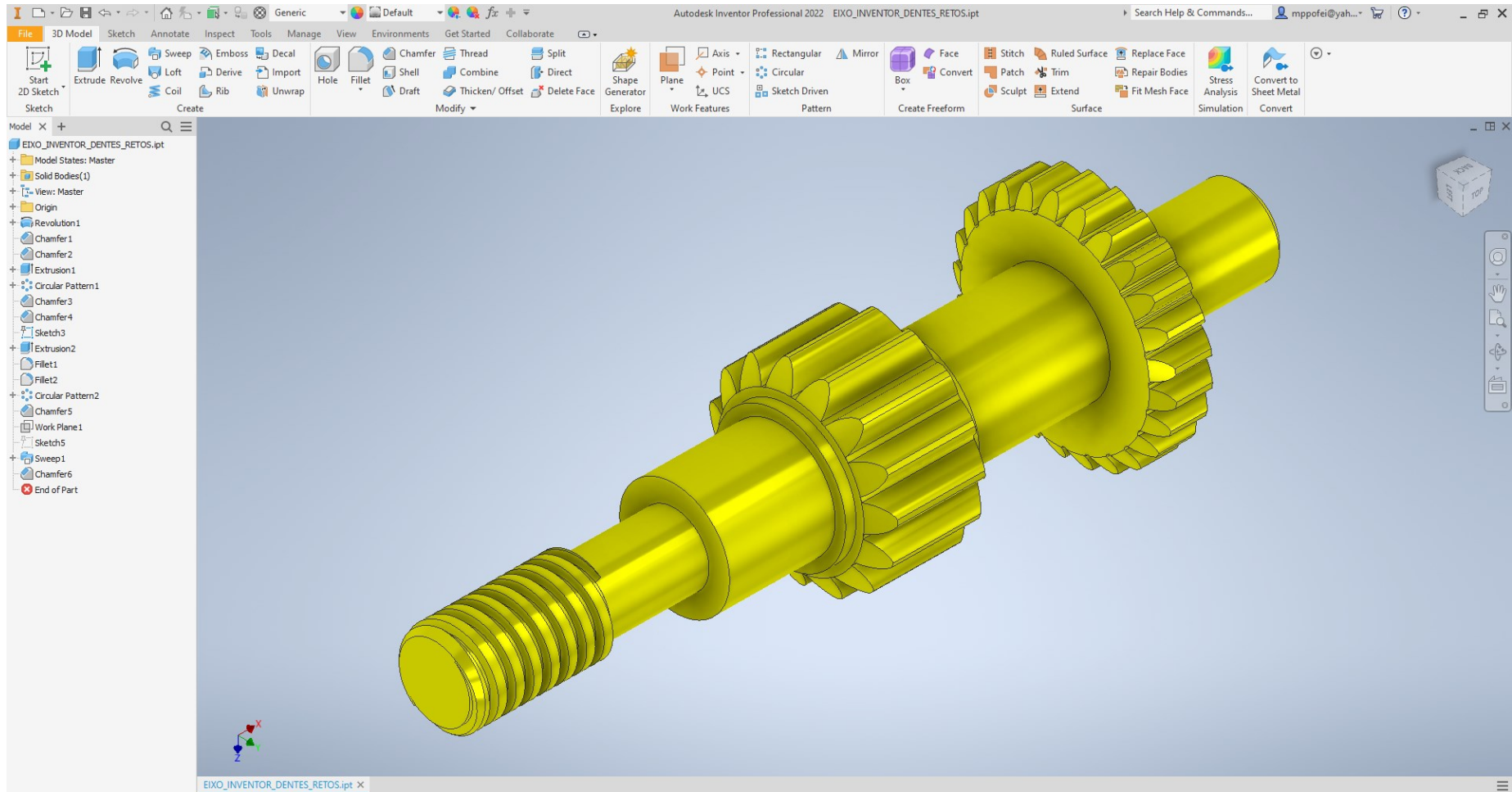

Modelo 3D no Autodesk Inventor

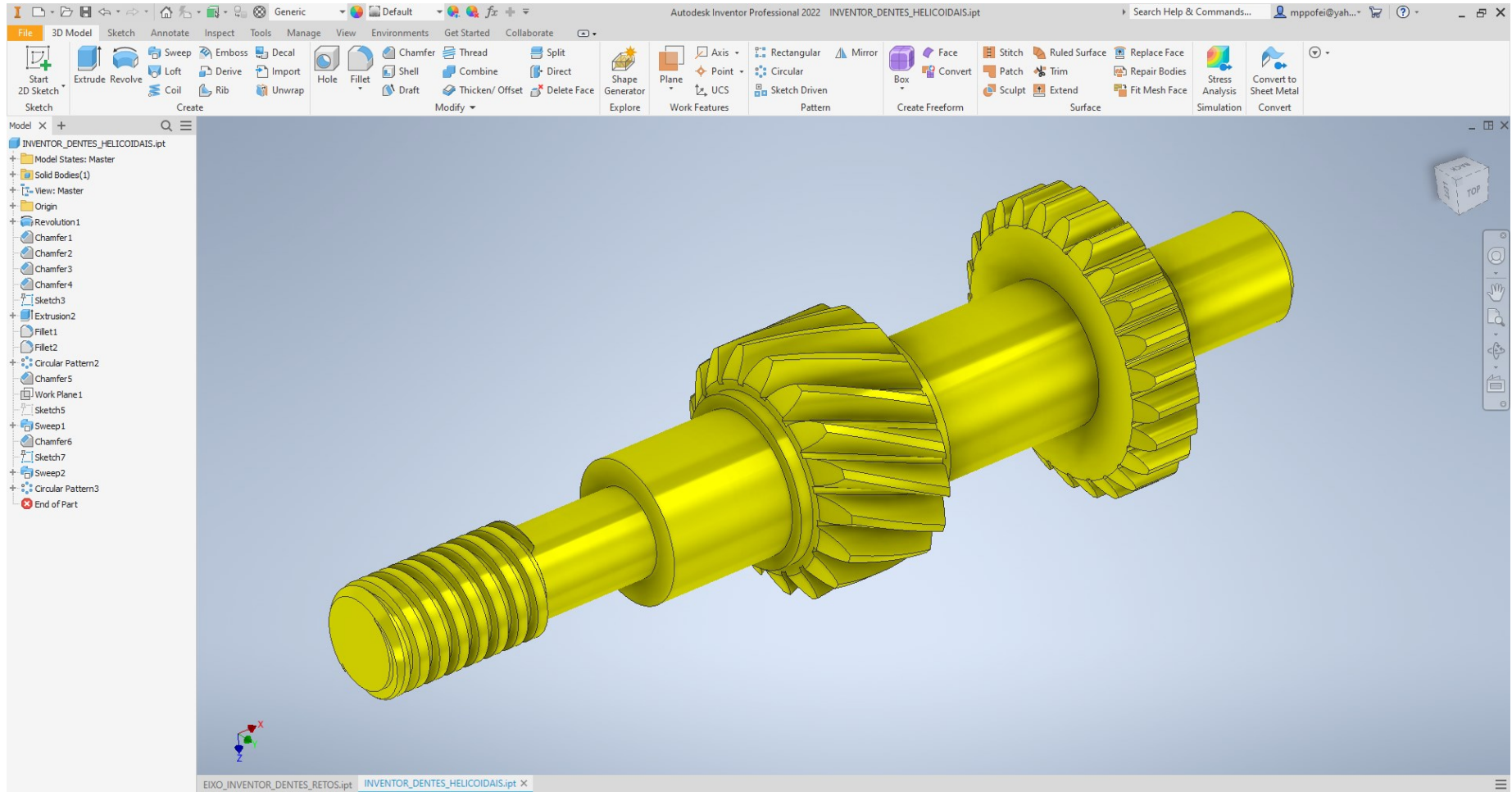

Obrigado e Fique com Deus



Proteção do Windows

Itens afetados:

file: C:\Users\Marcos Oliveira\AppData\Roaming\Autodesk\AutoCAD
2022\R24.1\enu\Support\acad.lsp

[Saiba mais](#)

É a rotina

Eu não sei retirar essa mensagem
pelo código.

Ações ▾

Colocar em quarentena

Remover

Permitir no dispositivo